

# FMH-A

## オイルホール穴付カッター用 フェイスミルアーバ

Face Mill Arbor (For Cutters with Oil Hole)

- ホルダインロー端面部からオイルホール穴付カッターへクーラント供給できます。  
Coolant flows from the end face of centering location to cutter with oil hole.

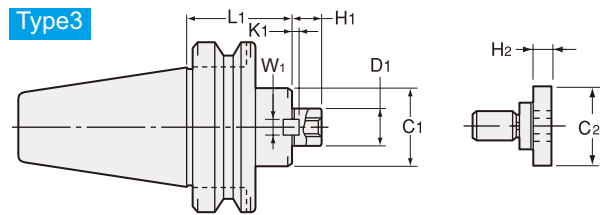
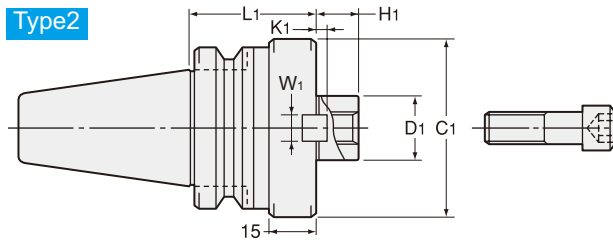
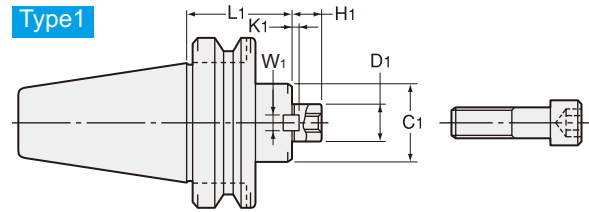
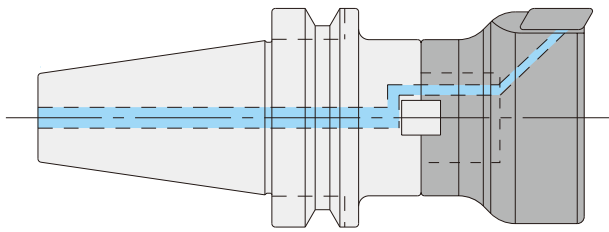

商品コード Code	型式 Model	Type	D1 (h6)	L1	C1	H1	W1	K1	C2	H2	—	締付ボルト Clamp bolt
0770 16116045	<b>BT30 -FMH16A -34 -45</b>	1	16	45	34	17	8	5	—	—	19,120	M8
0770 16116060	-60	1	16	60	34	17	8	5	—	—	19,120	
0770 16122045	<b>-FMH22A -47 -45</b>	2	22	45	47	18	10	5	—	—	19,550	M10
0770 16122060	-60	2	22	60	47	18	10	5	—	—	19,550	
0770 16123045	<b>-FMH22.225A -47 -45</b>	2	22.225	45	47	17	8	3.5	—	—	19,850	M10
0770 16123060	-60	2	22.225	60	47	17	8	3.5	—	—	19,850	
0770 16125060	<b>-FMH25.4A -60 -60</b>	2	25.4	60	60	22	9.5	5	—	—	20,150	M12
0770 16127060	-60	2	27	60	60	20	12	6	—	—	22,500	
0770 16316045	<b>BT40 -FMH16A -34 -45</b>	1	16	45	34	17	8	5	—	—	19,910	M8
0770 16316060	-60	1	16	60	34	17	8	5	—	—	19,910	
0770 16316075	-75	1	16	75	34	17	8	5	—	—	20,350	
0770 16316090	-90	1	16	90	34	17	8	5	—	—	20,350	
0770 16322045	<b>-FMH22A -47 -45</b>	1	22	45	47	18	10	5	—	—	23,210	M10
0770 16322060	-60	1	22	60	47	18	10	5	—	—	23,650	
0770 16322075	-75	1	22	75	47	18	10	5	—	—	23,870	
0770 16322090	-90	1	22	90	47	18	10	5	—	—	24,310	
0770 17322045	<b>-60 -45</b>	1	22	45	60	18	10	5	—	—	23,210	
0770 17322060	-60	1	22	60	60	18	10	5	—	—	23,650	
0770 17322075	-75	1	22	75	60	18	10	5	—	—	23,870	
0770 17322090	-90	1	22	90	60	18	10	5	—	—	24,310	
0770 16323045	<b>-FMH22.225A -47 -45</b>	1	22.225	45	47	17	8	3.5	—	—	23,210	
0770 16323060	-60	1	22.225	60	47	17	8	3.5	—	—	23,650	
0770 16323075	-75	1	22.225	75	47	17	8	3.5	—	—	23,870	
0770 16323090	-90	1	22.225	90	47	17	8	3.5	—	—	24,310	
0770 17323045	<b>-60 -45</b>	1	22.225	45	60	17	8	3.5	—	—	23,210	
0770 17323060	-60	1	22.225	60	60	17	8	3.5	—	—	23,650	
0770 17323075	-75	1	22.225	75	60	17	8	3.5	—	—	23,870	
0770 17323090	-90	1	22.225	90	60	17	8	3.5	—	—	24,310	
0770 16325060	<b>-FMH25.4A -60 -60</b>	1	25.4	60	60	22	9.5	5	—	—	23,650	M12
0770 16325075	-75	1	25.4	75	60	22	9.5	5	—	—	23,870	
0770 16325090	-90	1	25.4	90	60	22	9.5	5	—	—	24,310	
0770 16327060	<b>-FMH27A -60 -60</b>	1	27	60	60	20	12	6	—	—	23,650	M12
0770 16327075	-75	1	27	75	60	20	12	6	—	—	23,870	
0770 16327090	-90	1	27	90	60	20	12	6	—	—	24,310	
0770 17327060	<b>-76 -60</b>	2	27	60	76	20	12	6	—	—	23,650	
0770 17327075	-75	2	27	75	76	20	12	6	—	—	23,870	M16
0770 17327090	-90	2	27	90	76	20	12	6	—	—	24,310	
0770 16331060	<b>-FMH31.75A -76 -60</b>	2	31.75	60	76	30	12.7	7	—	—	23,870	M16
0770 16331075	-75	2	31.75	75	76	30	12.7	7	—	—	24,310	
0770 16331090	-90	2	31.75	90	76	30	12.7	7	—	—	24,640	
0770 17331060	<b>-96 -60</b>	2	31.75	60	96	30	12.7	7	—	—	34,120	
0770 17331075	-75	2	31.75	75	96	30	12.7	7	—	—	34,850	
0770 17331090	-90	2	31.75	90	96	30	12.7	7	—	—	35,600	
0770 16332060	<b>-FMH32A -96 -60</b>	2	32	60	96	22	14	7	—	—	34,120	M16
0770 16332075	-75	2	32	75	96	22	14	7	—	—	34,850	
0770 16332090	-90	2	32	90	96	22	14	7	—	—	35,600	

商品コード Code	型式 Model	Type	D1 (h6)	L1	C1	H1	W1	K1	C2	H2	—	締付ボルト Clamp bolt
0770 16516045	BT50 -FMH16A	-34 -45	1	16	45	34	17	8	5	—	—	33,470
0770 16516090		-90	1	16	90	34	17	8	5	—	—	33,810
0770 16516150		-150	1	16	150	34	17	8	5	—	—	34,270
0770 16516200		-200	1	16	200	34	17	8	5	—	—	35,650
0770 16516250		-250	1	16	250	34	17	8	5	—	—	65,550
0770 16516300		-300	1	16	300	34	17	8	5	—	—	78,360
0770 16522045	-FMH22A	-47 -45	1	22	45	47	18	10	5	—	—	33,470
0770 16522090		-90	1	22	90	47	18	10	5	—	—	36,230
0770 16522150		-150	1	22	150	47	18	10	5	—	—	38,760
0770 16522200		-200	1	22	200	47	18	10	5	—	—	39,100
0770 16522250		-250	1	22	250	47	18	10	5	—	—	65,550
0770 16522300		-300	1	22	300	47	18	10	5	—	—	78,360
0770 17522045		-60 -45	1	22	45	60	18	10	5	—	—	33,470
0770 17522090		-90	1	22	90	60	18	10	5	—	—	36,230
0770 17522150		-150	1	22	150	60	18	10	5	—	—	38,760
0770 17522200		-200	1	22	200	60	18	10	5	—	—	39,100
0770 17522250		-250	1	22	250	60	18	10	5	—	—	65,550
0770 17522300		-300	1	22	300	60	18	10	5	—	—	78,360
0770 16523045	-FMH22.225A	-47 -45	1	22.225	45	47	17	8	3.5	—	—	33,470
0770 16523090		-90	1	22.225	90	47	17	8	3.5	—	—	36,230
0770 16523150		-150	1	22.225	150	47	17	8	3.5	—	—	38,760
0770 16523200		-200	1	22.225	200	47	17	8	3.5	—	—	39,220
0770 16523250		-250	1	22.225	250	47	17	8	3.5	—	—	65,550
0770 16523300		-300	1	22.225	300	47	17	8	3.5	—	—	78,360
0770 17523045		-60 -45	1	22.225	45	60	17	8	3.5	—	—	33,470
0770 17523090		-90	1	22.225	90	60	17	8	3.5	—	—	36,230
0770 17523150		-150	1	22.225	150	60	17	8	3.5	—	—	38,760
0770 17523200		-200	1	22.225	200	60	17	8	3.5	—	—	39,220
0770 17523250		-250	1	22.225	250	60	17	8	3.5	—	—	65,550
0770 17523300		-300	1	22.225	300	60	17	8	3.5	—	—	78,360
0770 16525045	-FMH25.4A	-60 -45	1	25.4	45	60	22	9.5	5	—	—	33,470
0770 16525090		-90	1	25.4	90	60	22	9.5	5	—	—	36,230
0770 16525150		-150	1	25.4	150	60	22	9.5	5	—	—	38,760
0770 16525200		-200	1	25.4	200	60	22	9.5	5	—	—	39,220
0770 16525250		-250	1	25.4	250	60	22	9.5	5	—	—	65,550
0770 16525300		-300	1	25.4	300	60	22	9.5	5	—	—	78,360
0770 16527045	-FMH27A	-60 -45	1	27	45	60	20	12	6	—	—	33,470
0770 16527090		-90	1	27	90	60	20	12	6	—	—	36,230
0770 16527150		-150	1	27	150	60	20	12	6	—	—	38,760
0770 16527200		-200	1	27	200	60	20	12	6	—	—	39,220
0770 16527250		-250	1	27	250	60	20	12	6	—	—	65,550
0770 16527300		-300	1	27	300	60	20	12	6	—	—	78,360
0770 17527045		-76 -45	1	27	45	76	20	12	6	—	—	33,470
0770 17527090		-90	1	27	90	76	20	12	6	—	—	36,230
0770 17527150		-150	1	27	150	76	20	12	6	—	—	38,760
0770 17527200		-200	1	27	200	76	20	12	6	—	—	39,220
0770 17527250		-250	1	27	250	76	20	12	6	—	—	65,550
0770 17527300		-300	1	27	300	76	20	12	6	—	—	78,360
0770 16531045	-FMH31.75A	-76 -45	1	31.75	45	76	30	12.7	7	—	—	33,470
0770 16531105		-105	1	31.75	105	76	30	12.7	7	—	—	37,950
0770 16531150		-150	1	31.75	150	76	30	12.7	7	—	—	38,760
0770 16531200		-200	1	31.75	200	76	30	12.7	7	—	—	39,220
0770 17531045		-96 -45	1	31.75	45	96	30	12.7	7	—	—	33,470
0770 17531105	-105	1	31.75	105	96	30	12.7	7	—	—	37,950	
0770 17531150	-150	1	31.75	150	96	30	12.7	7	—	—	38,760	
0770 17531200	-200	1	31.75	200	96	30	12.7	7	—	—	39,220	
0770 16532045	-FMH32A	-96 -45	1	32	45	96	22	14	7	—	—	33,470
0770 16532105		-105	1	32	105	96	22	14	7	—	—	37,950
0770 16532150		-150	1	32	150	96	22	14	7	—	—	38,760
0770 16532200		-200	1	32	200	96	22	14	7	—	—	39,220
0770 16538045		-FMH38.1A	-80 -45	3	38.1	45	80	34	15.9	9	50	14
0770 16538075	-75		3	38.1	75	80	34	15.9	9	50	14	36,230
0770 16538105	-105		3	38.1	105	80	34	15.9	9	50	14	37,950
0770 16538150	-150		3	38.1	150	80	34	15.9	9	50	14	38,760
0770 17538045	-100 -45		3	38.1	45	100	34	15.9	9	50	14	33,470
0770 17538075	-75	3	38.1	75	100	34	15.9	9	50	14	36,230	
0770 17538105	-105	3	38.1	105	100	34	15.9	9	50	14	37,950	
0770 17538150	-150	3	38.1	150	100	34	15.9	9	50	14	38,760	
0770 16540045	-FMH40A	-100 -45	3	40	45	100	26	16	8.5	50	14	33,470
0770 16540075		-75	3	40	75	100	26	16	8.5	50	14	36,230
0770 16540105		-105	3	40	105	100	26	16	8.5	50	14	37,950
0770 16540150		-150	3	40	150	100	26	16	8.5	50	14	38,760
0770 16550045		-FMH50.8A	-100 -45	3	50.8	45	100	36	19.05	10	65	14
0770 16550075	-75		3	50.8	75	100	36	19.05	10	65	14	36,230
0770 16550105	-105		3	50.8	105	100	36	19.05	10	65	14	37,950
0770 16550150	-150		3	50.8	150	100	36	19.05	10	65	14	38,760

締付ボルトは付属しています。  
Clamp bolt is Included.

ご注文例 Ordering Example

**BT30 - FMH25.4A - 60 - 60**

シャンクサイズ  
Shank size

インロー径  
D1

フランジ径  
C1

突き出し長さ(L1)  
Projection length

# FMH-A

## オイルホール穴付カッター用 フェイスミルアーバ

Face Mill Arbor (For Cutters with Oil Hole)

- ホルダインロー端面部からオイルホール穴付カッターへクーラント供給できます。  
Coolant flows from the end face of centering location to cutter with oil hole.

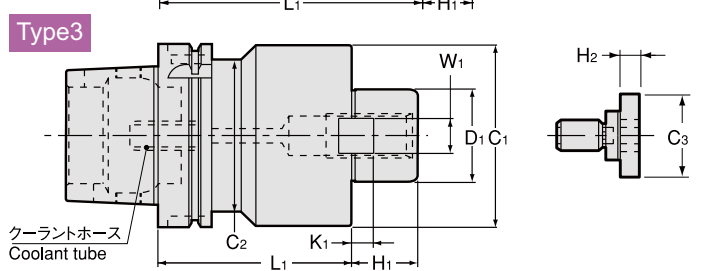
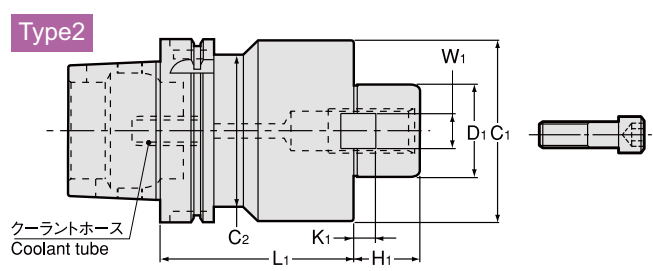
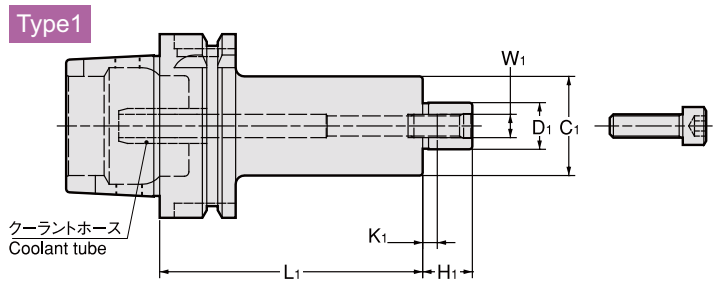
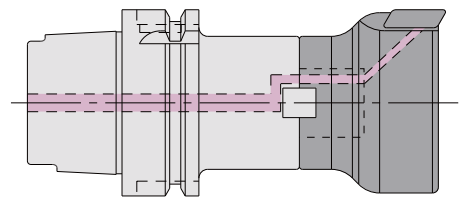

商品コード Code	型式 Model	Type	D1 (h6)	L1	C1	C2	H1	W1	K1	C3	H2	—	締付ボルト Clamp bolt
5350 13616060	HSK40A -FMH16A -34 -60	1	16	60	34	—	17	8	5	—	—	21,700	M8
5350 13622060	-FMH22A -47 -60	2	22	60	47	34	18	10	5	—	—	21,700	M10
5350 13623060	-FMH22.225A -47 -60	2	22.225	60	47	34	17	8	3.5	—	—	21,700	M10
5350 13625060	-FMH25.4A -60 -60	2	25.4	60	60	34	22	9.5	5	—	—	21,900	M12
5350 13627060	-FMH27A -60 -60	2	27	60	60	34	20	12	6	—	—	21,900	M12
5350 14616060	HSK50A -FMH16A -34 -60	1	16	60	34	—	17	8	5	—	—	21,700	M8
5350 14622060	-FMH22A -47 -60	2	22	60	47	42	18	10	5	—	—	21,700	M10
5350 14623060	-FMH22.225A -47 -60	2	22.225	60	47	42	17	8	3.5	—	—	21,900	M10
5350 14625060	-FMH25.4A -60 -60	2	25.4	60	60	42	22	9.5	5	—	—	21,900	M12
5350 14627060	-FMH27A -60 -60	2	27	60	60	42	20	12	6	—	—	21,900	M12
5350 15616060	HSK63A -FMH16A -34 -60 -H	1	16	60	34	—	17	8	5	—	—	21,700	M8
5350 15616090	-90 -H	1	16	90	34	—	17	8	5	—	—	21,900	M8
5350 15616120	-120 -H	1	16	120	34	—	17	8	5	—	—	22,300	M8
5350 15622060	-FMH22A -47 -60 -H	1	22	60	47	—	18	10	5	—	—	26,200	M10
5350 15622090	-90 -H	1	22	90	47	—	18	10	5	—	—	26,600	M10
5350 15622120	-120 -H	1	22	120	47	—	18	10	5	—	—	26,800	M10
5350 15722060	-60 -H	2	22	60	60	53	18	10	5	—	—	26,200	M10
5350 15722090	-90 -H	2	22	90	60	53	18	10	5	—	—	26,600	M10
5350 15722120	-120 -H	2	22	120	60	53	18	10	5	—	—	26,800	M10
5350 15623060	-FMH22.225A -47 -60 -H	1	22.225	60	47	—	17	8	3.5	—	—	26,200	M10
5350 15623090	-90 -H	1	22.225	90	47	—	17	8	3.5	—	—	26,600	M10
5350 15623120	-120 -H	1	22.225	120	47	—	17	8	3.5	—	—	26,800	M10
5350 15723060	-60 -H	2	22.225	60	60	53	17	8	3.5	—	—	26,200	M12
5350 15723090	-90 -H	2	22.225	90	60	53	17	8	3.5	—	—	26,600	M12
5350 15723120	-120 -H	2	22.225	120	60	53	17	8	3.5	—	—	26,800	M12
5350 15625060	-FMH25.4A -60 -60 -H	2	25.4	60	60	53	22	9.5	5	—	—	26,800	M12
5350 15625090	-90 -H	2	25.4	90	60	53	22	9.5	5	—	—	27,000	M12
5350 15625120	-120 -H	2	25.4	120	60	53	22	9.5	5	—	—	27,400	M12
5350 15627060	-FMH27A -60 -60 -H	2	27	60	60	53	20	12	6	—	—	26,800	M12
5350 15627090	-90 -H	2	27	90	60	53	20	12	6	—	—	27,000	M12
5350 15627120	-120 -H	2	27	120	60	53	20	12	6	—	—	27,400	M12
5350 15727060	-76 -60 -H	2	27	60	76	53	20	12	6	—	—	26,800	M12
5350 15727090	-90 -H	2	27	90	76	53	20	12	6	—	—	27,000	M12
5350 15727120	-120 -H	2	27	120	76	53	20	12	6	—	—	27,400	M12
5350 15631060	-FMH31.75A -76 -60 -H	2	31.75	60	76	53	30	12.7	7	—	—	26,800	M16
5350 15631090	-90 -H	2	31.75	90	76	53	30	12.7	7	—	—	27,000	M16
5350 15631120	-120 -H	2	31.75	120	76	53	30	12.7	7	—	—	27,400	M16
5350 15731060	-96 -60 -H	2	31.75	60	96	53	30	12.7	7	—	—	26,800	M16
5350 15731090	-90 -H	2	31.75	90	96	53	30	12.7	7	—	—	27,000	M16
5350 15731120	-120 -H	2	31.75	120	96	53	30	12.7	7	—	—	27,400	M16
5350 15632060	-FMH32A -96 -60 -H	2	32	60	96	53	22	14	7	—	—	29,400	M16
5350 15632090	-90 -H	2	32	90	96	53	22	14	7	—	—	29,700	M16
5350 15632120	-120 -H	2	32	120	96	53	22	14	7	—	—	30,100	M16

商品コード Code	型式 Model	Type	D1 (h6)	L1	C1	C2	H1	W1	K1	C3	H2	—	締付ボルト Clamp bolt
5350 17616075	HSK100A -FMH16A	-34 -75 -H	1	16	75	34	—	17	8	5	—	—	36,400
5350 17616105		-105 -H	1	16	105	34	—	17	8	5	—	—	36,700
5350 17616135		-135 -H	1	16	135	34	—	17	8	5	—	—	37,200
5350 17616150		-150 -H	1	16	150	34	—	17	8	5	—	—	39,200
5350 17616200		-200 -H	1	16	200	34	—	17	8	5	—	—	45,200
5350 17616250	-FMH22A	-250 -H	1	16	250	34	—	17	8	5	—	—	51,400
5350 17622075		-47 -75 -H	1	22	75	47	—	18	10	5	—	—	37,200
5350 17622105		-105 -H	1	22	105	47	—	18	10	5	—	—	37,600
5350 17622135		-135 -H	1	22	135	47	—	18	10	5	—	—	38,000
5350 17622150		-150 -H	1	22	150	47	—	18	10	5	—	—	40,100
5350 17622200	-60	-200 -H	1	22	200	47	—	18	10	5	—	—	46,200
5350 17622250		-250 -H	1	22	250	47	—	18	10	5	—	—	52,500
5350 17722075		-75 -H	1	22	75	60	—	18	10	5	—	—	37,200
5350 17722105		-105 -H	1	22	105	60	—	18	10	5	—	—	37,600
5350 17722135		-135 -H	1	22	135	60	—	18	10	5	—	—	38,000
5350 17722150	-FMH22.225A	-150 -H	1	22	150	60	—	18	10	5	—	—	40,100
5350 17722200		-200 -H	1	22	200	60	—	18	10	5	—	—	46,200
5350 17722250		-250 -H	1	22	250	60	—	18	10	5	—	—	52,500
5350 17623075		-47 -75 -H	1	22.225	75	47	—	17	8	3.5	—	—	37,200
5350 17623105		-105 -H	1	22.225	105	47	—	17	8	3.5	—	—	37,600
5350 17623135	-60	-135 -H	1	22.225	135	47	—	17	8	3.5	—	—	38,000
5350 17623150		-150 -H	1	22.225	150	47	—	17	8	3.5	—	—	40,100
5350 17623200		-200 -H	1	22.225	200	47	—	17	8	3.5	—	—	46,200
5350 17623250		-250 -H	1	22.225	250	47	—	17	8	3.5	—	—	52,500
5350 17723075		-75 -H	1	22.225	75	60	—	17	8	3.5	—	—	37,200
5350 17723105	-FMH25.4A	-105 -H	1	22.225	105	60	—	17	8	3.5	—	—	37,600
5350 17723135		-135 -H	1	22.225	135	60	—	17	8	3.5	—	—	38,000
5350 17723150		-150 -H	1	22.225	150	60	—	17	8	3.5	—	—	40,100
5350 17723200		-200 -H	1	22.225	200	60	—	17	8	3.5	—	—	46,200
5350 17723250		-250 -H	1	22.225	250	60	—	17	8	3.5	—	—	52,500
5350 17625075	-FMH27A	-60 -75 -H	1	25.4	75	60	—	22	9.5	5	—	—	37,200
5350 17625105		-105 -H	1	25.4	105	60	—	22	9.5	5	—	—	37,600
5350 17625135		-135 -H	1	25.4	135	60	—	22	9.5	5	—	—	38,000
5350 17625150		-150 -H	1	25.4	150	60	—	22	9.5	5	—	—	42,100
5350 17625200		-200 -H	1	25.4	200	60	—	22	9.5	5	—	—	48,500
5350 17627075	-76	-75 -H	1	27	75	60	—	20	12	6	—	—	37,200
5350 17627105		-105 -H	1	27	105	60	—	20	12	6	—	—	37,600
5350 17627135		-135 -H	1	27	135	60	—	20	12	6	—	—	38,000
5350 17627150		-150 -H	1	27	150	60	—	20	12	6	—	—	42,100
5350 17627200		-200 -H	1	27	200	60	—	20	12	6	—	—	48,500
5350 17727075	-FMH31.75A	-75 -H	1	27	75	76	—	20	12	6	—	—	37,200
5350 17727105		-105 -H	1	27	105	76	—	20	12	6	—	—	37,600
5350 17727135		-135 -H	1	27	135	76	—	20	12	6	—	—	38,000
5350 17727150		-150 -H	1	27	150	76	—	20	12	6	—	—	42,100
5350 17727200		-200 -H	1	27	200	76	—	20	12	6	—	—	48,500
5350 17631075	-96	-75 -H	1	31.75	75	76	—	30	12.7	7	—	—	37,200
5350 17631105		-105 -H	1	31.75	105	76	—	30	12.7	7	—	—	37,600
5350 17631135		-135 -H	1	31.75	135	76	—	30	12.7	7	—	—	38,000
5350 17631150		-150 -H	1	31.75	150	76	—	30	12.7	7	—	—	45,600
5350 17631200		-200 -H	1	31.75	200	76	—	30	12.7	7	—	—	51,600
5350 17731075	-FMH32A	-75 -H	2	31.75	75	96	85	30	12.7	7	—	—	37,200
5350 17731105		-105 -H	2	31.75	105	96	85	30	12.7	7	—	—	37,600
5350 17731135		-135 -H	2	31.75	135	96	85	30	12.7	7	—	—	38,000
5350 17731150		-150 -H	2	31.75	150	96	85	30	12.7	7	—	—	45,600
5350 17731200		-200 -H	2	31.75	200	96	85	30	12.7	7	—	—	51,600
5350 17632075	-FMH38.1A	-96 -75 -H	2	32	75	96	85	22	14	7	—	—	37,200
5350 17632105		-105 -H	2	32	105	96	85	22	14	7	—	—	37,600
5350 17632135		-135 -H	2	32	135	96	85	22	14	7	—	—	38,000
5350 17638075		-80 -75 -H	3	38.1	75	80	80	34	15.9	9	50	14	37,200
5350 17638105		-105 -H	3	38.1	105	80	80	34	15.9	9	50	14	37,600
5350 17638135	-100	-135 -H	3	38.1	135	80	80	34	15.9	9	50	14	38,000
5350 17738075		-75 -H	3	38.1	75	100	85	34	15.9	9	50	14	37,200
5350 17738105		-105 -H	3	38.1	105	100	85	34	15.9	9	50	14	37,600
5350 17738135		-135 -H	3	38.1	135	100	85	34	15.9	9	50	14	38,000
5350 17640075		-FMH40A	-100 -75 -H	3	40	75	100	85	26	16	8.5	50	14
5350 17640105	-105 -H		3	40	105	100	85	26	16	8.5	50	14	37,600
5350 17640135	-135 -H		3	40	135	100	85	26	16	8.5	50	14	38,000
5350 17650075	-100 -75 -H		3	50.8	75	100	85	36	19.05	10	65	14	37,200
5350 17650105	-FMH50.8A		-105 -H	3	50.8	105	100	85	36	19.05	10	65	14
5350 17650135		-135 -H	3	50.8	135	100	85	36	19.05	10	65	14	38,000

HSK63A、HSK100Aには標準でマニュアルクランプ穴が空いています。  
 HSK63A, HSK100A have manual clamp holes in the shank.

締付ボルトは付属しています。  
 Clamp bolt is Included.

ご注文例 Ordering Example

マニュアルクランプ穴無し (HSK40A, HSK50A)

Without manual clamping hole (HSK40A, HSK50A)

**HSK50A - FMH16A - 34 - 60**  
 シャンクサイズ    インロー径    フランジ径    突き出し長さ(L)  
 Shank size                    D1                    C1                    Projection length

ご注文例 Ordering Example

マニュアルクランプ穴付き (HSK63A, HSK100A)

With manual clamping hole (HSK63A, HSK100A)

**HSK63A - FMH16A - 34 - 60 - H**  
 シャンクサイズ    インロー径    フランジ径    突き出し長さ(L)    マニュアルクランプ穴付  
 Shank size                    D1                    C1                    Projection length    With manual clamping hole

- BT
- AHO
- HSK-A/E/F/C
- HSK-T
- C
- UTS
- 専用機
- 関連機器
- ジョイントリ
- ミリーシヤキヤク
- Milling Chuck
- コイルホルダ
- Coiler Holder
- Rゼロホルダ
- R Zero Holder
- ハイドロシヤク
- Hydraulic Chuck
- スリソクフィ
- Srink Fit
- タッピングシヤク
- Tapping Chuck
- アーバ類
- Arbors
- マルチホブシステム
- Multiple tool system
- 機能付ホルダ
- Function Holder
- HSK-E
- HSK-F
- HSK-C
- シャンク規格
- Shank Dimensions

# FMH-A

## オイルホール穴付カッター用 フェイスミルアーバ

Face Mill Arbor (For Cutters with Oil Hole)

- ホルダイナーロー端面部からオイルホール穴付カッターへクーラント供給できます。  
Coolant flows from the end face of centering location to cutter with oil hole.

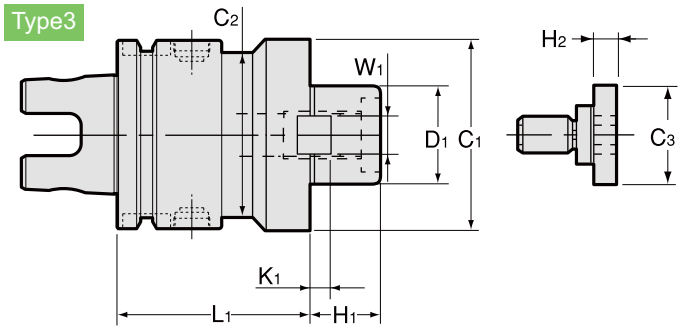
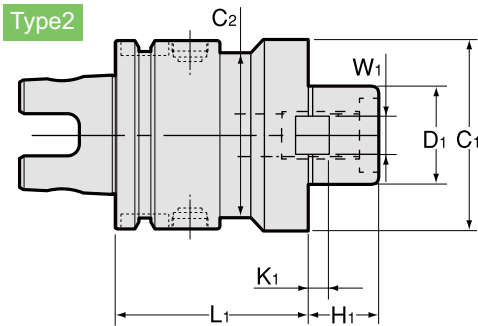
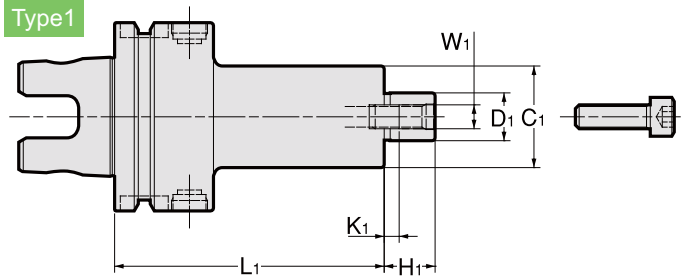
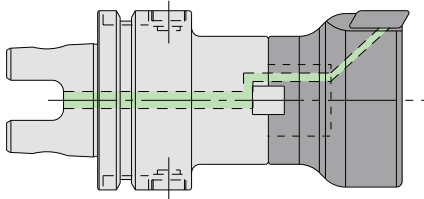

商品コード Code	型式 Model	Type	D1 (h6)	L1	C1	C2	H1	W1	K1	C3	H2	—	締付ボルト Clamp bolt
1320 51116060	<b>UTS5040 -FMH16A -34 -60-H</b>	1	16	60	34	—	17	8	5	—	—	26,730	M8
1320 51122060	<b>-FMH22A -47 -60-H</b>	1	22	60	47	—	18	10	5	—	—	26,730	M10
1320 51123060	<b>-FMH22.225A -47 -60-H</b>	1	22.225	60	47	—	17	8	3.5	—	—	26,730	M10
1320 51125060	<b>-FMH25.4A -60 -60-H</b>	2	25.4	60	60	50	22	9.5	5	—	—	26,950	M12
1320 51127060	<b>-FMH27A -60 -60-H</b>	2	27	60	60	50	20	12	6	—	—	26,950	M12
1320 5※216060	<b>UTS6350 -FMH16A -34 -60</b>	1	16	60	34	—	17	8	5	—	—	26,730	M8
1320 5※216090		1	16	90	34	—	17	8	5	—	—	26,730	M8
1320 5※216120		1	16	120	34	—	17	8	5	—	—	26,950	M8
1320 5※222060	<b>-FMH22A -47 -60</b>	1	22	60	47	—	18	10	5	—	—	26,730	M10
1320 5※222090		1	22	90	47	—	18	10	5	—	—	26,950	M10
1320 5※222120		1	22	120	47	—	18	10	5	—	—	27,390	M10
1320 5※222060		1	22	60	60	—	18	10	5	—	—	26,730	M10
1320 5※222090		1	22	90	60	—	18	10	5	—	—	26,950	M10
1320 5※222120		1	22	120	60	—	18	10	5	—	—	27,390	M10
1320 5※223060	<b>-FMH22.225A -47 -60</b>	1	22.225	60	47	—	17	8	3.5	—	—	26,730	M10
1320 5※223090		1	22.225	90	47	—	17	8	3.5	—	—	26,950	M10
1320 5※223120		1	22.225	120	47	—	17	8	3.5	—	—	27,390	M10
1320 5※223060		1	22.225	60	60	—	17	8	3.5	—	—	26,730	M10
1320 5※223090		1	22.225	90	60	—	17	8	3.5	—	—	26,950	M10
1320 5※223120		1	22.225	120	60	—	17	8	3.5	—	—	27,390	M10
1320 5※225060	<b>-FMH25.4A -60 -60</b>	1	25.4	60	60	—	22	9.5	5	—	—	32,230	M12
1320 5※225090		1	25.4	90	60	—	22	9.5	5	—	—	32,670	M12
1320 5※225120		1	25.4	120	60	—	22	9.5	5	—	—	32,670	M12
1320 5※227060	<b>-FMH27A -60 -60</b>	1	27	60	60	—	20	12	6	—	—	32,230	M12
1320 5※227090		1	27	90	60	—	20	12	6	—	—	32,670	M12
1320 5※227120		1	27	120	60	—	20	12	6	—	—	32,670	M12
1320 5※227060		2	27	60	76	63	20	12	6	—	—	32,230	M12
1320 5※227090		2	27	90	76	63	20	12	6	—	—	32,670	M12
1320 5※227120		2	27	120	76	63	20	12	6	—	—	32,670	M12
1320 5※231060	<b>-FMH31.75A -76 -60</b>	2	31.75	60	76	63	30	12.7	7	—	—	32,230	M16
1320 5※231090		2	31.75	90	76	63	30	12.7	7	—	—	32,670	M16
1320 5※231120		2	31.75	120	76	63	30	12.7	7	—	—	32,670	M16
1320 5※231060		2	31.75	60	96	63	30	12.7	7	—	—	32,230	M16
1320 5※231090		2	31.75	90	96	63	30	12.7	7	—	—	32,670	M16
1320 5※231120		2	31.75	120	96	63	30	12.7	7	—	—	32,670	M16
1320 5※232060	<b>-FMH32A -96 -60</b>	2	32	60	96	63	22	14	7	—	—	32,230	M16
1320 5※232090		2	32	90	96	63	22	14	7	—	—	32,670	M16
1320 5※232120		2	32	120	96	63	22	14	7	—	—	32,670	M16



商品コード Code	型式 Model	Type	D1 (h6)	L1	C1	C2	H1	W1	K1	C3	H2	—	締付ボルト Clamp bolt		
1320 5※316075	UTS10080 -FMH16A	-34	-75	1	16	75	34	—	17	8	5	—	44,770	M8	
1320 5※316105			-105	1	16	105	34	—	17	8	5	—	45,100		
1320 5※316135			-135	1	16	135	34	—	17	8	5	—	45,760		
1320 5※322075	-FMH22A	-47	-75	1	22	75	47	—	18	10	5	—	45,760	M10	
1320 5※322105			-105	1	22	105	47	—	18	10	5	—	46,200		
1320 5※322135			-135	1	22	135	47	—	18	10	5	—	46,750		
1320 5※322075	-60	-75	-105	1	22	75	60	—	18	10	5	—	45,760	M10	
1320 5※322105			-105	1	22	105	60	—	18	10	5	—	46,200		
1320 5※322135			-135	1	22	135	60	—	18	10	5	—	46,750		
1320 5※323075	-FMH22.225A	-47	-75	1	22.225	75	47	—	17	8	3.5	—	45,760	M10	
1320 5※323105			-105	1	22.225	105	47	—	17	8	3.5	—	46,200		
1320 5※323135			-135	1	22.225	135	47	—	17	8	3.5	—	46,750		
1320 5※323075	-60	-75	-105	1	22.225	75	60	—	17	8	3.5	—	45,760	M10	
1320 5※323105			-105	1	22.225	105	60	—	17	8	3.5	—	46,200		
1320 5※323135			-135	1	22.225	135	60	—	17	8	3.5	—	46,750		
1320 5※325075	-FMH25.4A	-60	-75	1	25.4	75	60	—	22	9.5	5	—	45,760	M12	
1320 5※325105			-105	1	25.4	105	60	—	22	9.5	5	—	46,200		
1320 5※325135			-135	1	25.4	135	60	—	22	9.5	5	—	46,750		
1320 5※327075	-FMH27A	-60	-75	1	27	75	60	—	20	12	6	—	45,760	M12	
1320 5※327105			-105	1	27	105	60	—	20	12	6	—	46,200		
1320 5※327135			-135	1	27	135	60	—	20	12	6	—	46,750		
1320 5※327075	-76	-75	-105	1	27	75	76	—	20	12	6	—	45,760	M12	
1320 5※327105			-105	1	27	105	76	—	20	12	6	—	46,200		
1320 5※327135			-135	1	27	135	76	—	20	12	6	—	46,750		
1320 5※331075	-FMH31.75A	-76	-75	1	31.75	75	76	—	30	12.7	7	—	45,760	M16	
1320 5※331105			-105	1	31.75	105	76	—	30	12.7	7	—	46,200		
1320 5※331135			-135	1	31.75	135	76	—	30	12.7	7	—	46,750		
1320 5※331075	-96	-75	-105	1	31.75	75	96	—	30	12.7	7	—	45,760	M16	
1320 5※331105			-105	1	31.75	105	96	—	30	12.7	7	—	46,200		
1320 5※331135			-135	1	31.75	135	96	—	30	12.7	7	—	46,750		
1320 5※332075	-FMH32A	-96	-75	1	32	75	96	—	22	14	7	—	45,760	M16	
1320 5※332105			-105	1	32	105	96	—	22	14	7	—	46,200		
1320 5※332135			-135	1	32	135	96	—	22	14	7	—	46,750		
1320 5※338075	-FMH38.1A	-80	-75	3	38.1	75	80	80	34	15.9	9	50	14	45,760	MBAH-M20
1320 5※338105			-105	3	38.1	105	80	80	34	15.9	9	50	14	46,200	
1320 5※338135			-135	3	38.1	135	80	80	34	15.9	9	50	14	46,750	
1320 5※338075	-100	-75	-105	3	38.1	75	100	100	34	15.9	9	50	14	45,760	MBAH-M20
1320 5※338105			-105	3	38.1	105	100	100	34	15.9	9	50	14	46,200	
1320 5※338135			-135	3	38.1	135	100	100	34	15.9	9	50	14	46,750	
1320 5※340075	-FMH40A	-100	-75	3	40	75	100	100	26	16	8.5	50	14	45,760	MBAH-M20
1320 5※340105			-105	3	40	105	100	100	26	16	8.5	50	14	46,200	
1320 5※340135			-135	3	40	135	100	100	26	16	8.5	50	14	46,750	
1320 5※350075	-FMH50.8A	-100	-75	3	50.8	75	100	100	36	19.05	10	65	14	45,760	MBAH-M24
1320 5※350105			-105	3	50.8	105	100	100	36	19.05	10	65	14	46,200	
1320 5※350135			-135	3	50.8	135	100	100	36	19.05	10	65	14	46,750	

商品コードの※は低圧用では0、高圧用では1となります。

1. 締付ボルトは付属しています。
2. UTS5040 は高圧用のみになります。
1. Clamp bolt is Included.
2. Only high pressure type is available for UTS5040.

ご注文例 Ordering Example

低圧用 Low pressure type

0 ~ 1.0MPa (UTS10080 のみ 0 ~ 2.0MPa)

**UTS6350 - FMH25.4A - 60 - 60**

シャンクサイズ      インロー径      フランジ径      突き出し長さ(L1)  
Shank size              D1                      C1                      Projection length

ご注文例 Ordering Example

高圧用 High pressure type

1.1 ~ 7.0MPa (UTS10080 のみ 2.1 ~ 7.0MPa)

**UTS6350 - FMH25.4A - 60 - 60 - H**

シャンクサイズ      インロー径      フランジ径      突き出し長さ(L1)      高圧の場合  
Shank size              D1                      C1                      Projection length      High pressure type